



SERIE FILETTATA

TII FILETTATO			PVC	POLIPROPILENE
codice	diámetro			
	16	3/8		
	20	1/2		
	25	3/4		
	32	1"		
	40	1"1/4		
	50	1"1/2		
	63	2"		
	75	2"1/2		
	90	3"		
	110	4"		

GOMITO 90°			PVC	POLIPROPILENE
codice	diámetro			
	16	3/8		
	20	1/2		
	25	3/4		
	32	1"		
	40	1"1/4		
	50	1"1/2		
	63	2"		
	75	2"1/2		
	90	3"		
	110	4"		

GOMITO 90° FILETTATO "MASCHIO - FEMMINA"			POLIPROPILENE
codice	diámetro		
	20	1/2	
	25	3/4	
	32	1"	

GOMITO 45°			PVC
codice	diámetro		
	20	1/2	
	25	3/4	
	32	1"	
	40	1"1/4	
	50	1"1/2	
	63	2"	
	75	2"1/2	
	90	3"	
	110	4"	

SERIE FILETTATA

NIPPLO FILETTATO				PVC	POLIPROPILENE
codice	diametro				
	16	3/8			
	20	1/2			
	25	3/4			
	32	1"			
	40	1"1/4			
	50	1"1/2			
	63	2"			
	75	2"1/2			
	90	3"			
	110	4"			

BOCCHETTONE FILETTATO				PVC
codice	diametro			
	16	3/8		
	20	1/2		
	25	3/4		
	32	1"		
	40	1"1/4		
	50	1"1/2		
	63	2"		
	75	2"1/2		
	90	3"		
	110	4"		

NIPPLO RIDOTTO				PVC	POLIPROPILENE
codice	diametro				
	20 - 16	1/2	- 3/8		
	25 - 20	3/4	- 1/2		
	32 - 25	1"	- 3/4		
	40 - 32	1"1/4	- 1"		
	50 - 40	1"1/2	- 1"1/4		
	63 - 50	2"	- 1"1/2		
	75 - 63	2"1/2	- 2"		
	90 - 75	3"	- 2"1/2		
	110 - 90	4"	- 3"		

NIPPLO RIDOTTO SPECIALE				POLIPROPILENE
codice	diam. - magg.			
	32	1"		
	40	1"1/4		
	50	1"1/2		
	63	2"		

SERIE FILETTATA

TAPPO FILETTATO MASCHIO				PVC	POLIPROPILENE
codice	diametro				
	16	3/8			
	20	1/2			
	25	3/4			
	32	1"			
	40	1"1/4			
	50	1"1/2			
	63	2"			
	75	2"1/2			
	90	3"			
	110	4"			

CALOTTA FILETTATA				PVC	POLIPROPILENE
codice	diametro				
	16	3/8			
	20	1/2			
	25	3/4			
	32	1"			
	40	1"1/4			
	50	1"1/2			
	63	2"			
	75	2"1/2			
	90	3"			
	110	4"			

MANICOTTO FILETTATO				PVC	POLIPROPILENE
codice	diametro				
	16	3/8			
	20	1/2			
	25	3/4			
	32	1"			
	40	1"1/4			
	50	1"1/2			
	63	2"			
	75	2"1/2			
	90	3"			
	110	4"			

MANICOTTO RIDOTTO				PVC	POLIPROPILENE
codice	diametro				
	20 - 16	1/2 - 3/8			
	25 - 20	3/4 - 1/2			
	32 - 25	1" - 3/4			
	40 - 32	1"1/4 - 1"			
	50 - 40	1"1/2 - 1"1/4			
	63 - 50	2" - 1"1/2			
	75 - 63	2"1/2 - 2"			
	90 - 75	3" - 2"1/2			
	110 - 90	4" - 3"			

SERIE FILETTATA

MAGGIORATORE FEMMINA				PVC	POLIPROPILENE
codice	diametro	M	F		
	20 - 16	1/2	- 3/8		
	25 - 20	3/4	- 1/2		
	32 - 25	1"	- 3/4		
	40 - 32	1"1/4	- 1"		
	50 - 40	1"1/2	- 1"1/4		
	63 - 50	2"	- 1"1/2		
	75 - 63	2"1/2	- 2"		
	90 - 75	3"	- 2"1/2		
	110 - 90	4"	- 3"		

MAGGIORATORE FEMMINA SPECIALE			PVC	POLIPROPILENE
codice	liam. - magg	am. - magg.		
	32	1"		
	40	1"1/4		
	50	1"1/2		
	63	2"		

RIDUZIONE FEMMINA FIL. LUNGA				PVC	POLIPROPILENE
codice	diametro	M	F		
	20 - 16	1/2	- 3/8		
	25 - 20	3/4	- 1/2		
	32 - 25	1"	- 3/4		
	40 - 32	1"1/4	- 1"		
	50 - 40	1"1/2	- 1"1/4		
	63 - 50	2"	- 1"1/2		
	75 - 63	2"1/2	- 2"		
	90 - 75	3"	- 2"1/2		
	110 - 90	4"	- 3"		

RIDUZIONE FEMMINA SPECIALE LUNGA			PVC	POLIPROPILENE
codice	liam. - magg	M		
	25	3/4		
	32	1"		
	40	1"1/4		
	50	1"1/2		
	63	2"		
	75	2"1/2		
	90	3"		
	110	4"		

SERIE FILETTATA

BUSSOLA DI RIDUZIONE FEMMINA			PVC	POLIPROPILENE
CORTA				
codice	liam. - Magg	M		
	25	3/4		
	32	1"		
	40	1"1/4		
	50	1"1/2		
	63	2"		
	75	2"1/2		
	90	3"		
	110	4"		

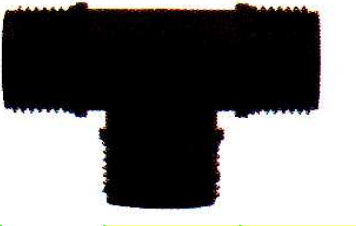
TEE MASCHIO			POLIPROPILENE
CORTA			
codice	diametro		
	20	1/2	
	25	3/4	
	32	1"	
	40	1"1/4	

PORTAGOMMA			PVC	POLIPROPILENE
codice	diametro - fil			
	16	3/8		
	20	1/2		
	25	3/4		
	32	1"		
	40	1"1/4		
	50	1"1/2		
	63	2"		
	75	2"1/2		
	90	3"		

CROCE FILETTATA FEMMINA			POLIPROPILENE
codice	diametro		
	63	2"	
	90	3"	

VALVOLE A SFERA IN PVC

VALVOLE A SFERA GRIGIE MONIGHIERA FF CON GIUNTO		PVC	
codice	diametro		
16	3/8		
20	1/2		
25	3/4		
32	1"		
40	1"1/4		
50	1"1/2		
63	2"		



VALVOLE A SFERA GRIGIE MONIGHIERA FIL. F - F		PVC	
codice	diametro		
16	3/8		
20	1/2		
25	3/4		
32	1"		
40	1"1/4		
50	1"1/2		
63	2"		
75	2"1/2		
90	3"		
110	4"		



VALVOLE A SFERA GRIGIE MONIGHIERA FIL. M - F		PVC	
codice	diametro		
16	3/8		
20	1/2		
25	3/4		
32	1"		
40	1"1/4		
50	1"1/2		
63	2"		

